

AIR PURIFIER

USER MANUAL

CAC-D2010FW

CUCKOO



CUCKOO

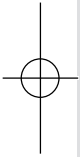

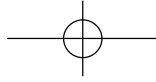

To our customers! Thank you for choosing Cuckoo Air Purifier.

Please keep this User Manual (including the Warranty) for your reference. This manual will guide you when you have any questions or when the product does not work properly.



Merits of Cuckoo Air Purifier

- **Air Purification**
This product filters out fine dust that is airborne using an Ultra PM 2.5 filter mounted at the inlet of the product.
- **Toxic Gas purification**
Removes harmful gas and odors that are airborne to make sure your home is safe.
- **Fan Speed Control**
Set your preferred fan speed.
- **Set Timer**
Set a custom timer for your air purifier. Perfect for automatic On/Off function.
- **4-Level Automatic Pollution Detector Sensor**
The product detects the pollution status of the air indoors in real time through the Pollution Sensor. When Automatic Operation setting is selected, the product automatically controls the power output according to the surrounding pollution degree to make the indoor environment pleasant.
- **Air Quality Display**
The product automatically detects the cleanliness of the indoor air through the Pollution Sensor and displays the cleanliness. Also, the light can be turned ON/OFF by using the Power-Saving function.

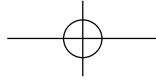





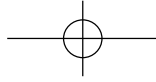

CONTENTS

Before Use	● Merits of Cuckoo Air Purifier	2
	Warnings for Safe Use	4 ~ 7
	Name of Parts / Accessories	8 ~ 9
How to Use	● Details to Check before Use	10
	Names and Functions of Control & Display Panel	11 ~ 12
	Names and Functions of Display Panel & Cleanliness Indicator	13
	Self Diagnostic Mode / Basic Operations	14
	Basic Operations	14 ~ 15
	Operating Modes	16 ~ 20
	Operation Status by Modes	21 ~ 22
	Other Settings	23 ~ 26
	Cleaning and Maintenance Guide	27 ~ 29
	How To Replace Filters	30
Before Asking for Support	● Please check before asking for Support	31
Service Guide	● Product Specifications and Inquiry about Malfunction	32







Warnings for Safe Use

- Please comply with the 'Warnings for Safe Use' as they are provided to ensure safe and proper use of the device and prevent accidents and dangerous situations.
- The 'Warnings for Safe Use' section is divided into 'Warning' and 'Caution' which are defined as follows.

<p> Warning Potentially dangerous situation that can cause serious injuries or death if not avoided.</p>	<p> • This symbol is to remind you to be cautious about a potentially dangerous situation under special circumstances.</p>
<p> Caution Potentially dangerous situation that can cause minor injuries if not avoided.</p>	<p> • Please read the details carefully and follow the instructions to avoid dangerous situations.</p> <p> • This symbol is used to indicate actions that are prohibited.</p> <p> • This symbol is used to indicate 'instruction' actions.</p>

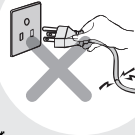
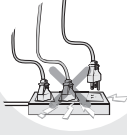
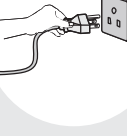
About Power Supply

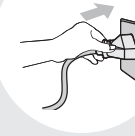
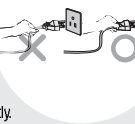
<p> Warning  Do not</p> <p>Do not bend, tie or pull the power cord by force.</p> <ul style="list-style-type: none"> • This may cause electric shock or fire due to a short circuit. Please check the state of the Power Cord frequently. 		<p>Stop the use and contact Customer Service when the power cord or plug is damaged or the power outlet is loose.</p> 
<p>Plug the power plug into a 120V outlet with at least a rating of 10A and power surge protection. Do not plug in multiple devices into the same power outlet or extension cord simultaneously.</p> <ul style="list-style-type: none"> • When multiple devices are plugged into the same power outlet or if the device is plugged into an inappropriate power input, it may cause heating, fire and electric shock. • If there is a foreign substance or water on the power plug, please wipe it clean before plugging it into the socket. • Use an extension cord of 10A or higher. 		<p>• If the sheath of the Power Cord is peeled off or chopped during use due to negligence, it may cause fire or electric shock. Thus, please check the state of the Power Cord, Power Plug and Power Outlet frequently.</p> <p>• To replace the damaged power cord or plug, please visit CUCKOO website and contact Customer Service to prevent dangerous situations.</p> <p>• We strongly recommend that the damaged parts be repaired or replaced.</p> <p>• Otherwise, this may cause electric shock or fire due to a short circuit.</p>
<p>Use 120V power input only.</p> <ul style="list-style-type: none"> • This may cause electric shock or fire. • The device will not operate properly. • Please check the state of the power cord and plug frequently. 		<p>When putting in or pulling out the Power Plug, first remove moisture from your hands and then put in or pull out the Power Plug by holding the Power Plug.</p>  <ul style="list-style-type: none"> • Pulling out the Power Plug with wet hands can cause electric shock. • Pulling the power cord by force can damage the cord and may cause a short circuit or electric shock. Please check the state of the power cord and plug frequently.
<p>Wipe off any foreign substance from the Power Plug with a dry cloth.</p> <ul style="list-style-type: none"> • This may cause electric shock or fire. Please check the state of the power plug frequently. 		<p>Please unplug the device before cleaning the machine.</p>  <ul style="list-style-type: none"> • There is a risk of electric shock or malfunction. Please check the state of the Power Plug and the Power Cord frequently. <p>Do not pull the Power Cord when unplugging the product.</p>  <ul style="list-style-type: none"> • Force applied to the power cord may cause electric shock or fire. Please check the state of the power cord and plug frequently.

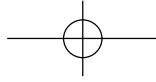

Warnings for Safe Use

About Power Supply

Warning **Do not**

Do not put the product or anything heavy on the Power Cord.

- This may cause damage to the Power Cord that could lead to fire, electric shock, or fall of the product.



When moving the product, do not pull the Power Cord.

- It may cause a damage to the product, electric shock, or fire. Please check the state of the Power Cord frequently.

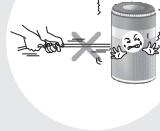

Make sure the power cord is not under a heavy object or near sharp objects. Please ensure that it is not damaged by your pet.

- If the power cord is damaged, it may cause electric shock or fire. Please check the state of the power cord frequently.

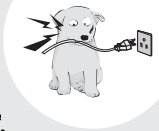

If the power supply area is wet, unplug the product and let it dry completely before use.

- This may cause electric shock or fire. Please check the state of the Power Plug and the Power Cord frequently.



Please turn off the product by pressing the power button. Also, unplug the product before inspection, repair or replacement of its components.

- This may cause electric shock or breakdown. Please check the state of the power cord frequently.



Do not put in and pull out the Power Plug continuously.

- This may cause electric shock or fire.

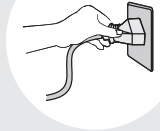

Do not randomly connect or process the Power Cord.

- This may cause electric shock or fire.

Installation Guide

Warning **Do not**

Do not use the product outdoors where the product may get in contact with direct sunlight, rain or snow or places with moisture such as a laundry room or a bathroom.

- This may cause fire or electric shock due to heating and short circuit.



Do not place it in a bumpy or slanted area. Do not place it on a rug, cushion or laminated floor.

- This may cause malfunction, unwanted noise or injury. Please check the state of the product frequently.



Do not keep or use insecticides, combustible gas, inflammables, or toxic substances near the product.

- This may cause fire or a deformation or malfunction of the product.



Do not use the product where smell, smoke, or oil is generated such as a restaurant or a barbecue restaurant.

- This may cause a decrease in the performance.



Do not install the product in a place with excessive oil or smoke for industrial purposes or metallic dust.

- This may cause fire or a malfunction of the product.

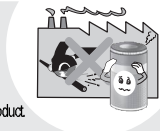

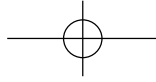

Warnings for Safe Use

Installation Guide

Warning **Caution**

Place the product at least 20inch away on the sides and 24inch away on the top from the wall and surrounding objects.

- Keep these distances for optimal performance.

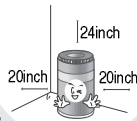

Please check if there is any obstacle around the product to ensure good air circulation.

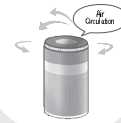

Place it at least 80inch away from electronic products such as a TV.

- This may cause a radio interference.

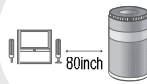

Open the windows for ventilation before using gas appliances, combustibles and other inflammables.



- There is a risk of explosion or fire.

Do not use the product to remove toxic gases such as carbon monoxide.

- This may cause a malfunction of the product.

Do not install or use the product near a curtain.

- The Pollution Sensor may not work properly.



Do not use the product as a ventilating fan or hoods for gas stove or electric ranges in the kitchen.

- This may cause poor performance of the product and filters.

Do not use the product for anything other than its intended purpose, e.g. preserving artworks, maintaining precision instruments and animal breeding.

- If you do not do so, it may cause electric shock or fire.

During Use

Warning **Do not**

Do not put any obstruction around the Air Inlet or the Air Outlet of the product.

- This may cause poor performance, abnormal noise, or malfunction of the product.



Do not put your finger or any other foreign substances such as a stick into the Air Inlet or the Air Outlet.

- You may get injured by the fan rotating at a high speed.
- This may cause a malfunction of the product.



If there is abnormal noise, smoke, or smell is emitted from the product, first pull out the Power Plug, and then contact our Customer Service Center.

- This may cause fire, burns, or injury.

www.CUCKOOAMERICA.com

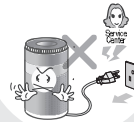

Do not inject a toxic substance such as smoke of a cigarette into the porous part on the side of the product, or poke with a sharp object.

- This may cause a malfunction of the product, fire or electric shock.

Do not put heat of fire near the product.

- This may cause a malfunction or deformation of the product or fire.

Do not clean the interior of the purifier yourself please contact Customer Service for technical support.

- Otherwise it may cause malfunction of the product or an electric shock.



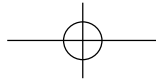

Warnings for Safe Use

During Use



Warning



Do not

Never soak the product in water.

- There is a risk of electric shock.



Do not place a bowl with water, drugs, foods, small metallic materials, inflammables, etc. on top of the product.

- If spilled, the products may cause electric shock, fire, or damage.



Do not sprinkle inflammables such as an insecticide or an air freshener to the Air Inlet.

- It may cause fire or poor performance of the product.



Do not clean the product by spraying water or wiping out with benzene, thinner, etc.



Do not stand on top of the product or put anything heavy.

- It may cause a malfunction of the product or injury due to fall or damages.



If it's wet, contact our Customer Service Center.

- There is a risk of malfunction or electric shock.



Please avoid using it near a heating device.

- It may cause fire or electric shock.



Wash the Pre-Filter with water on a regular basis and dry it well before use.

- Otherwise it may cause a reduced performance of the product.
- Dry it in the shade.



This product should not be used by people including children who lack physical or mental abilities, experience and knowledge to use the product properly without instruction.

- Do not let children play with the product.
- It may cause electric shock or injury.



Please replace the filters in a timely manner.

- It may cause poor performance of the product.



Do not turn OFF by pulling the plug.

- It may cause an electric shock or malfunction of the product.



Do not push nor lean on the product. It may fall to the ground.

- It may cause an injury or malfunction of the product.



Do not move the product while it is working.

- It may cause fire or electric shock or partial damage to the product.



After cleaning, please make sure to put the parts in their original position.

- Otherwise it may cause malfunction of the product.

When opening the Filter Cover, please be careful not to let your body or any other foreign material get stuck in the product.

- It may cause an injury or malfunction of the product.



Do not lay the product for use.

- It may cause malfunction of the product.

Be careful of any raised spot or obstruction on the floor when moving the product that may cause a scratch or damage to it.

- Although wheels are mounted on the bottom of the product for its mobility, the product has fairly low floor for its design.



Do not put the product near a window or places where the wind of an air conditioner or a heater can reach.

- It may cause malfunction of the sensors.



After cooking, ventilate sufficiently before operating the product to purify air in the room.

When turning off the product, be sure to press the power button to turn product off.

- This may cause product malfunction.

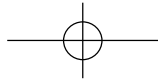

Name of Parts / Accessories

Name of Parts

Front

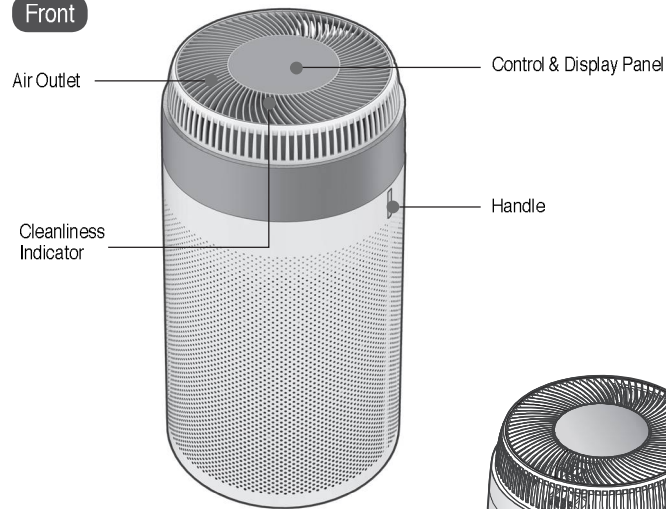

Back

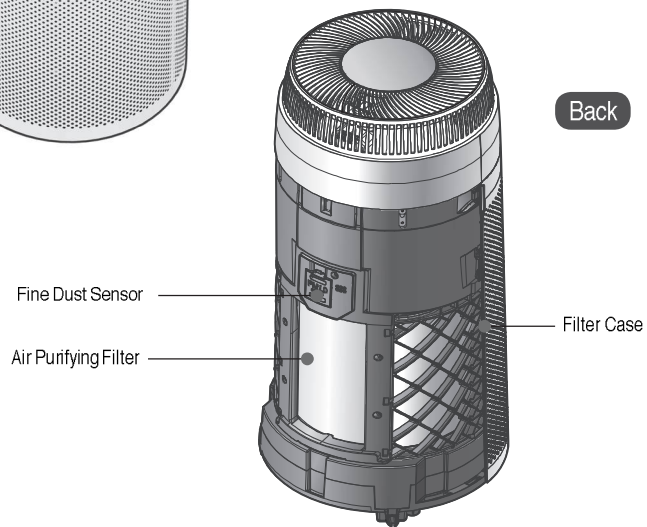

Accessories

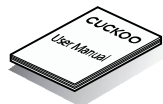

User Manual



Functional Filter

※ The picture may differ from the actual product.

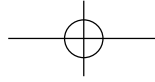

Name of Parts

Air Filters

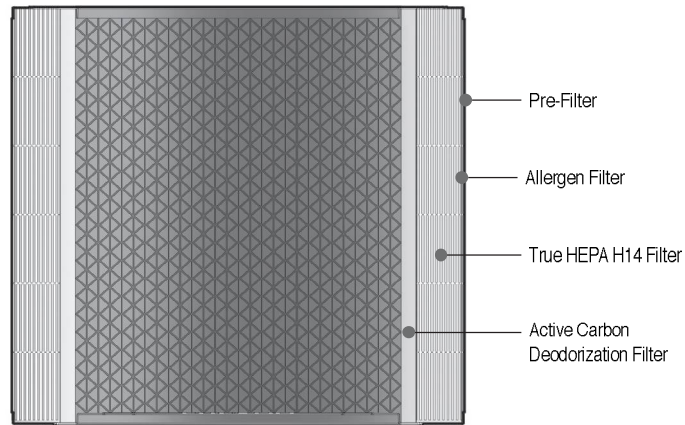

※The picture may differ from the actual product.

Section	Air Filter
Level 1	Pre-Filter
Level 2	Allergen Filter
Level 3	True HEPA H14 Filter
Level 4	Active Carbon Deodorization Filter

Filter Functions

	Pre-Filter	Removes large dust, hair, pet fur, etc.
Functional Filter	Allergen Filter	Removes allergic substances from the air.
Ultra-Deo PM 2.5 Filter	True HEPA H14 Filter	Filters mites, pollens, fine dust, and smoke.
	Active Carbon Deodorization Filter	Activated Carbon Deodorizing Filter removes odors, harmful gas, cigarettes, animal fur, NO ₂ .

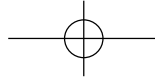

Details to Check Before Use

Caution

Caution: When the product is not in use, please unplug the unit. This product is exclusively for 120V 60Hz. Apply appropriately.

Details to Check Before Use

- 1** Open the filter cover.
 - ▶ Open the filter cover from the upper left part of the unit.
 - ※ Do not forcefully remove from the bottom of the unit.
- 2** Take out the filter and remove the vinyl wrapping.
 - ▶ After removing the packaging vinyl, Please insert in product.
 - ▶ Please make sure the filter is inserted properly with the upper part on top.
- 3** Reassemble the Filter Cover onto the product.
 - ▶ Be careful not to get any of your body or foreign material stuck in the product when reassembling the cover.
 - Please be careful when reassembling the product, may cause injury or malfunction of the unit.
- 4** Connecting the power
 - ▶ This product is exclusively for 120V. Please connect the product to the appropriate Power Outlet.
- 5** Press the "On/Off" button to operate the unit. Also, Press the "Mode" button to set the desired option.
 - ※ Make sure the filter is assembled correctly before operating the product.
- 6** Press the "On/Off" button to shut off the unit.
 - ▶ Once the unit is shut off, allow 10 seconds for the fan to completely shut off.
 - ▶ All the indicators on the Display Panel will be turned OFF.

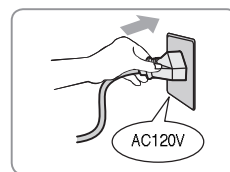
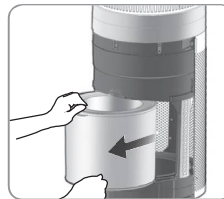
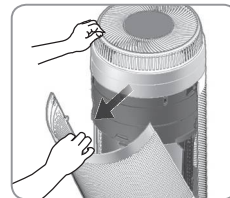

Names/Functions of the Control/Display Panel

Control Panel

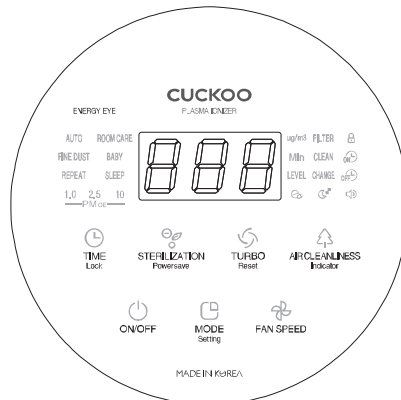

• **ON/OFF** : To turn the unit on and off.



• **MODE** : Select the desired mode.

※ Each time the button is pressed, the mode changes in the order of AUTO, ROOM CARE, FINE DUST, BABY, REPEAT and SLEEP.



• **Fan Speed** : Adjust the fan speed in manual mode.

※ Each time the button is pressed, the speed setting changes in the order of BREEZE(Level 1), LOW(Level 2), MEDIUM(Level 3) and HIGH(Level 4).



• **TIME** : Preset AUTO ON/OFF and set time for REPEAT.



• **AIR STERILIZATION** : Turn on and off the Plasma Ionizer.

※ Press the button, and the STERILIZATION button will be turned ON, and the Plasma Ionizer will start working. If you press the button again, the button will be turned OFF, and the Plasma Ionizer will stop.

※ Press the button continuously for 3 seconds or longer to start the power saving mode, and press it for 3 seconds or longer to return to previous operation mode.



• **TURBO** : Select the TURBO mode.

※ Press this button to turn on "Turbo Mode" To return to the previous mode, press the "Turbo Mode" button again.



• **MODE** : Used to set the function mode.

※ Press the "Mode" button for 3 seconds or longer to enter "Setting Mode"

※ In the first setting mode, pick your language.

※ Continue to press "Mode" to scan through the options. Voice volume setting, filter replacement/cleaning, sensor sensitivity, screen light, energy eye, turbo operation time, auto mode max air volume setting.

▶ Refer to How to Set Others in pages 23-26.

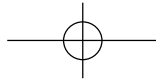

Names/Functions of the Control/Display Panel

Control Panel



• **BUTTON LOCK** : Locks the buttons

※ To activate the "Button Lock" function hold down the "Time" button for 3 seconds or more. (The "time button" will flicker 3 times when activated.)



※ In the lock mode, press the button for three seconds to unlock the buttons. ("UL_" flickers three times on the display panel when the lock is released.)

※ When Button Lock is set, "UL_" indicates, and "Loc" flickers three times on the display panel when any button other than TIME is pressed.



• **Air Cleanliness Display** - Displays current air quality

※ Each time the button is pressed during operation, the corresponding fine dust concentration is displayed for 5 seconds sequentially.

(PM10 → PM2.5 → PM1.0 → PM10 ...)

※ PM10: Fine dust (size of particles less than 10 μ m)

PM2.5: Ultra fine dust (particle size less than 2.5 μ m)

PM1.0: Super fine dust (particle size is less than 1 μ m)

※ This indicator goes on when the button is pressed for three seconds or longer while the unit is in operation and goes off when the button is pressed for another three seconds.

Display Panel

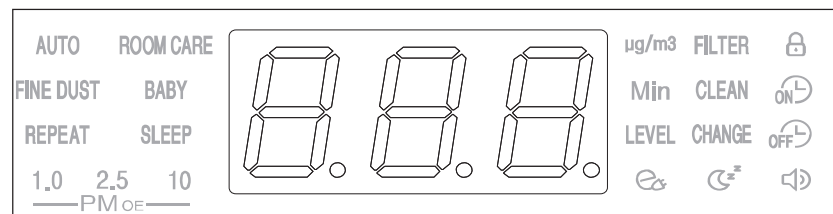

- **AUTO** : This indicates the product is in automatic air purification mode.
- **FINE DUST** : This indicates the product is in fine dust air purification mode.
- **REPEAT** : This indicates the product is in repeated air purification mode.
- **ROOM CARE** : This indicates the product is in room care air purification mode.
- **BABY** : This indicates the product is in air purification for baby mode.
- **SLEEP** : This indicates the product is in air purification during sleep mode.
- **PM 1.0 / 2.5 / 10** – This indicates the corresponding fine dust concentration level.
- **ug/m3** – This indicates the fine dust concentration.
- **FILTER / CLEAN / CHANGE** – This indicates filter needs to be replaced.
- **BUTTON LOCK (UL_)** : This indicates when the Button Lock function is set.
- **AUTO ON (ON)** : This indicates when the AUTO ON function is set.
- **AUTO OFF (OFF)** : This indicates when the AUTO OFF function is set.
- **POWER SAVE (e)** – This indicates Power Saving mode is activated.
- **ENERGE SAVE (e*)** – This indicates Energy Saving mode is activated.
- **888SEG / Min / LEVEL** – This indicates operation status, time and step according to mode.
- **VOICE (b)** : This indicates the Voice function is on. (voice setting function)

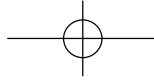

Names/Functions of Display Panel & Cleanliness Indicator & Cleanliness Indicator



Display Panel

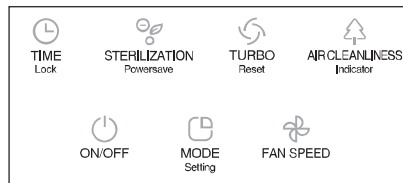

- **ON/OFF** : This indicates operation of the product. It goes off when the product stops operating.
- **MODE** : Each time this button is pressed, the mode changes in the order of AUTO, ROOM CARE, FINE DUST, BABY, REPEAT and SLEEP.
- **FAN SPEED** : This indicates the manual operation function is on.
- **TIME** : This indicator goes on when AUTO ON, AUTO OFF or REPEAT function is selected.
- **STERILIZATION** : This indicator will appear when the Plasma Ionizer is activated.
- **TURBO** : This indicates the product is in TURBO mode.
- **AIR CLEANLINESS** : This indicates for five seconds when AIR CLEANLINESS is selected.

Cleanliness Indicator

- **Cleanliness Indicator**: This displays the cleanliness of the surrounding area with colors.

Pollution Level	Level 1 (Clean)	Level 2	Level 3	Level 4	Level 5	Level 6 (Pollution)
Air cleanliness Indicator	Blue	Teal	Green	Yellow	Purple	Red

- ※ If you do not operate the product in any way after connecting the Power Plug, no display will show. Press the ON/OFF button to start operating the product.
- ※ Make sure you hear a beeping noise when pressing the button. The Control & Display Panel may look different from the actual appearance on the product.
- ※ Different fan speeds may affect the product performance for air purification.
- ※ The indicator turns on automatically when either SLEEP, BABY or MANUAL mode is selected.
- ※ To display air cleanliness, press the AIR CLEANLINESS button for three seconds. The settings are applied until the operation is shut. (Sleep mode and infant mode are set back to default when the power plug is removed.)
- ※ If multiple air cleaning products are being used in the same room, the ultrafine dust indicator readings may not be accurate.
- ※ The cleanliness color and the fine dust concentration value may be different to detected air pollution.

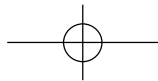

Self Diagnostic Mode / Basic Operation

Self Diagnostic Mode

When the unit is not working properly, the display panel will show an alert.
If there is an alert that will not disappear, please contact our customer service center.



This indicates a malfunction of the Filter Cover.

Remount the filter cover.

If the issue is not fixed, please contact our Customer Service Center.

Basic Operation

- ❶ Insert the plug into a wall outlet.
 - ▶ The product will enter waiting mode with a beeping sound.

- ❷ Press the ON/OFF button.
 - ▶ ON/OFF and AUTO icons are lit up on the Display Panel, and the fan starts operating.
The 3-digit display shows the current fan speed.
 - ※ It runs in the previous operating mode. (Except TURBO)
 - ※ If the Filter Cover is not mounted, an error code will show on the 3-digit display.

- ❸ Press MODE to select the desired operating mode.
 - ▶ Each time the button is pressed, the mode changes in the order of AUTO, ROOMCARE, FINE DUST, BABY, REPEAT and SLEEP.

- ❹ Press FAN SPEED to select the desired fan speed.
 - ▶ Pressing FAN SPEED changes the operating mode to MANUAL. Each time the button is pressed, the speed setting changes in the order of BREEZE(Level 1), LOW(Level 2), MEDIUM(Level 3) and HIGH(Level 4).

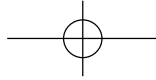

Basic Operation

- 5 Press TIME to set the duration for the unit to go off.
 - ▶ You can set the OFF timer while it's running by pressing the TIME button.
 - ※ It flickers for three seconds and then stays on when the timer is set.
 - ※ You can set the timer from 1 to 12 hours in units of an hour.
 - ※ Preset the time to be "0H", and the AUTO OFF mode will be canceled.

- 6 Press STERILIZATION to activate the Plasma Ionizer.
 - ▶ If you press the button, the ion generation operation of the Plasma Ionizer will start and the icon will be turned ON. To stop it, press the button while the Plasma Ionizer is in running.
 - ※ The Plasma Ionizer may make a crackling noise which is normal.

- 7 Press TURBO to change the operating mode.
 - ▶ Select this mode to speed up the air purification for the maximum fan speed.
 - ※ TURBO indicator is turned on when this mode is selected.
 - ※ To return to the previous operating mode, press the button again.

- 8 Press AIR CLEANLINESS to gauge the ultra-fine dust concentration.
 - ▶ Each time the button is pressed during operation, the corresponding fine dust concentration is displayed for 5 seconds sequentially.
(PM10→PM2.5→PM1.0→PM10...)
 - ※ PM10: Fine dust (size of particles less than 10 μ m)
PM2.5: Ultra fine dust (particle size less than 2.5 μ m)
PM1.0: Super fine dust (particle size is less than 1 μ m)

- 9 Press AIR CLEANLINESS button for three or longer seconds to select the cleanliness indicator.
 - ▶ Each time the button is pressed for three or longer seconds, the cleanliness indicator is turned on or off.
 - ※ The indicator turns on automatically when AUTO, ROOM CARE, FINE DUST, REPEAT or TURBO is selected.

- 10 To stop the unit, press the ON/OFF button again.
 - ▶ All the lights of the Display Panel and the Front Display Panel will be turned OFF, and the product will enter waiting mode.

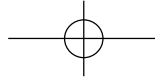

Operating Modes

Operating Modes

AUTO

AUTO mode detects the air quality and will automatically adjust the necessary fan speed.



- In the standby mode, press the ON/OFF button once. Initially, the unit will run in AUTO mode. If a different mode was selected it will maintain your selected operating mode.
- It senses the air quality and adjusts the fan speed.
- Shows current fan speed and cleanliness of air during the operation.
- Press the AIR CLEANLINESS button for at least three seconds to activate or deactivate the cleanliness indicator.

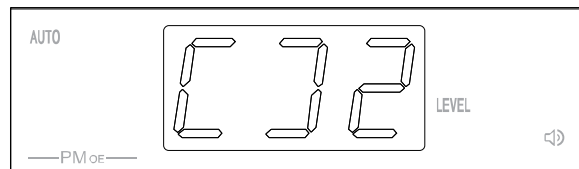

Room Care Air Purification

Automatically adjusts to the surrounding environment.



- In AUTO mode, press the MODE button once.
- It will automatically control the fan speed using preset algorithm.
- It shows the current fan speed and cleanliness of air during operation.
- Press the AIR CLEANLINESS button for least three seconds to activate or deactivate the cleanliness indicator.

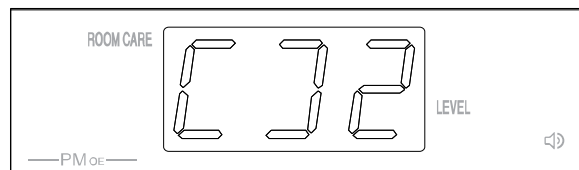

* The control and display panel may appear different than the image above.

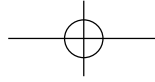

Operating Modes



FINE DUST

Is a setting that automatically adjusts to eliminate fine dust.



- In AUTO mode, press the MODE button twice.
- It auto controls the fan speed using the preset algorithm.
- It shows the current fan speed and cleanliness of air during operation.
- Press the AIR CLEANLINESS button for at least three seconds to activate or deactivate the cleanliness indicator.

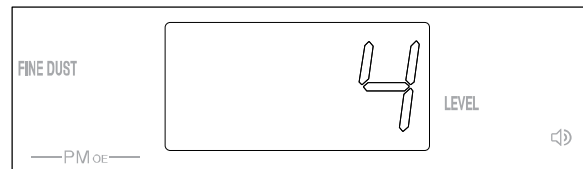

BABY

Is a setting for sterilizing the environment for infants at the lowest noise level.



- In AUTO mode, press the MODE button three times.
- It minimizes the air volume and operates the STERILIZATION function to help babies sleep well.
- Initially, the display panel shows MODE indicator for five seconds, and then only BABY mode stays on.
- The cleanliness indicator initially stays on for five seconds and then it will be turned off.

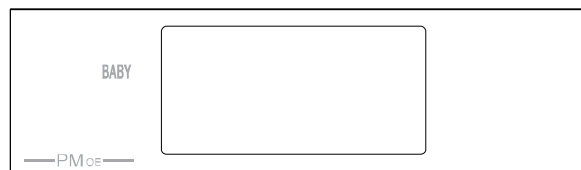

* The control and display panel may appear differently than the image above.

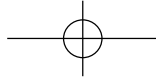

Operating Modes

REPEAT

Once your timer is set, it will automatically repeat based on the selected time.



- In AUTO mode, press the MODE button four times.
- Press the TIME button to set up the repeating time. (The timer can be set from 1 to 12 hours in units of an hour.)
- If no TIME button is present, it repeats running and stopping hourly.
- If a mode was set previously, it runs on the previous set time.
- It repeats running and stopping depending on the set time.
- The operation is the same as in the AUTO mode.

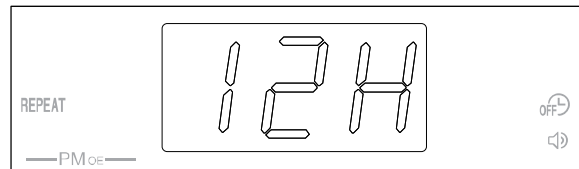

SLEEP

Is a setting made for sleep, operating at a low sound level.



- In AUTO mode, press the MODE button five times.
- Minimizes air volume for a peaceful experience.
- Initially, the display panel shows MODE indicator for five seconds, and then only SLEEP mode stays on.
- The cleanliness indicator initially stays on for five seconds and then it will be turned off.
- To activate the cleanliness indicator, press the AIR CLEANLINESS button for three seconds or longer. It stays on until the power plug is pulled out.

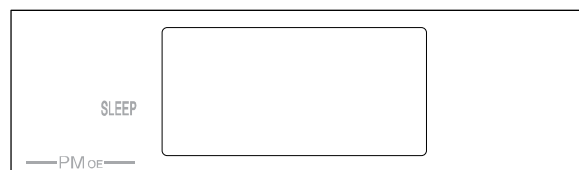

※ The control and display panel may appear differently than the image above.

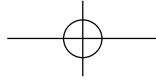

Operating Modes



ENERGY SAVE

Detects indoor lighting and adjusts accordingly

- When the Energy Eye Night Sensor senses darkness during operation, all indicators including the cleanliness indicator are turned off, and the Power Saving option is turned on.
- Power saving is activated when light is detected. Manual activation is also available.
 - ※ Please refer to Other Settings in page 25 for how to set the Energy Eye function.

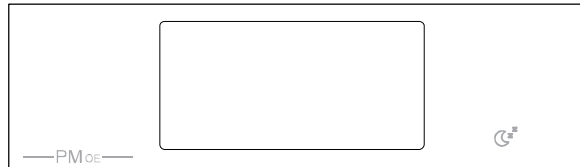

MANUAL

Mode that operates by selecting the desired fan strength



- Press the FAN SPEED.
- Select FAN SPEED from Low, Medium, or High.
- The cleanliness indicator will remain on for five seconds and then it will shut off.
- To turn on the cleanliness indicator, press the AIR CLEANLINESS button for three seconds or longer.

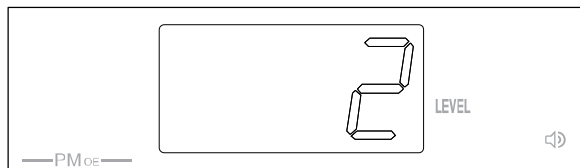

※ The control and display panel may appear differently than the image above.

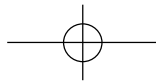

Operating Modes

TURBO

Quickly remove dust with maximum performance



- Press the TURBO button to activate.
- The fan will speed up to the maximum speed to purify the air.
- It shows the current fan speed and cleanliness of air during operation.
- Press the AIR CLEANLINESS button for at least three seconds to activate or deactivate the cleanliness indicator.
- The running time for TURBO mode can be changed in the settings.

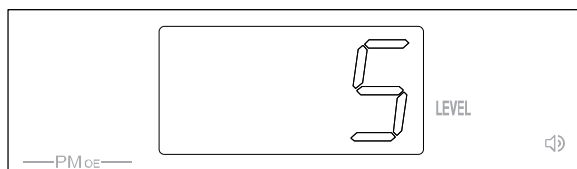

POWER SAVING

Mode that efficiently manages energy when air is kept clean for a certain period

- Press the air sterilization button continuously for more than 3 seconds during operation.
- FAN operation is controlled according to cleanliness and ambient brightness by operating with minimum energy consumption.
- If the indoor air is kept clean for a certain period of time, "E" will light up and manage energy efficiently.
- The air cleanliness indicator can be selected and released by pressing the air cleanliness indicator button for 3 seconds or longer.

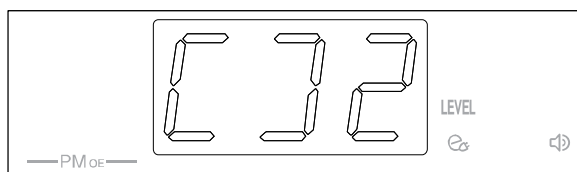

※ The control and display panel may appear differently than the image above.

Operation Status by Modes

Operation Status by Modes

AIR CLEANLINESS

- See the status of the air quality by pressing AIR CLEANLINESS button during operation.

Pollution Level	Level 1 (Clean)	Level 2	Level 3	Level 4	Level 5	Level 6 (Pollution)
Air cleanliness Indicator	Blue	Teal	Green	Yellow	Purple	Red

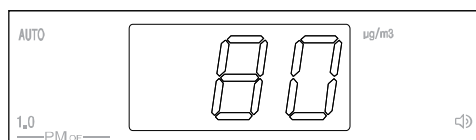

※ When different products are used in the same room, the air cleanliness and pollution level may differ due to the air flow.

STERILIZATION

- Press the STERILIZATION button to activate Plasma Ionizer and the STERILIZATION icon will be displayed on the panel panel. To turn it off, press the button again.



AUTO OFF

- Press the TIME button to set the Auto Off option.
- Each time the TIME button is pressed, time increases by an hour up to 12 hours.
- Automatically stops running after the set time.

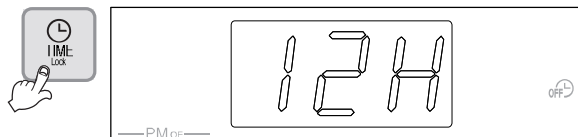

※ The control and display panel may appear differently than the image above.

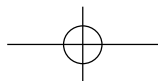

Operation Status

AUTO ON

- In standby mode, press the TIME button to set the AUTO ON option.
- Each time the TIME button is pressed, set time increases by an hour for up to 12 hours.
- Automatically starts running after the set time. (Initially, it runs in the AUTO mode. If a different mode was set previously, it runs in the last set mode.)

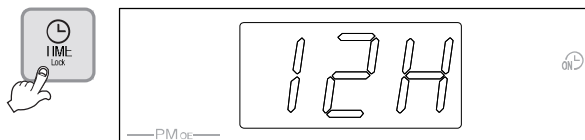

BUTTON LOCK

- Press the TIME button for three seconds or longer to set this option.
- To unlock the buttons, press the TIME button again for three seconds or longer.

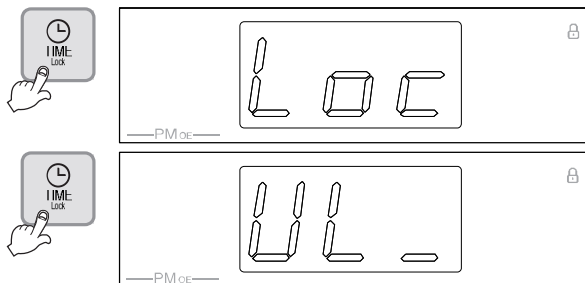

Filter Replacement / Filter Clean Alert

- Alert for filter replacement or filter cleaning will appear. Once the filters are replaced, reset the alarm for filter replacement.
- There are three ways to replace filter.
 - Opening and closing the filter cover with the power connected to the unit initializes the filter replacement / cleaning notification.
 - Press the Turbo operation button continuously for more than 3 seconds in standby mode (all function indicator lamps are turned off) The filter replacement / cleaning notification is reset.
 - Removing the product from the power outlet will reset the filter replacement cleaning notification.
- The filter replacement and cleaning cycle may vary depending on the surrounding environment.

※The control and display panel may appear differently than the image above.

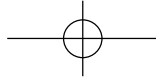

Other Settings

How to Choose LANGUAGE

The guide voice can be set in English, Spanish, Korean or Chinese.
The default language is English.

- ❶ Insert the plug to a wall outlet and in the standby mode with all indicators off, press the MODE button for three seconds or longer. (If the purifier is running, press the ON/OFF button to stop it.)
 - ❷ “En” is displayed on the control panel as shown in the picture below.
 - ❸ Press the FAN SPEED button to select En for English, ES for Spanish, kr for Korean or cn for Chinese.
 - ❹ Press the ON/OFF button to save the setting.
- * The setting is canceled if the TIME button is pressed or the power is off.
* The setting is automatically canceled if left idle for 20 seconds or longer.

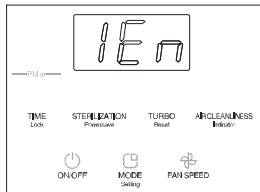

[When setting English language]

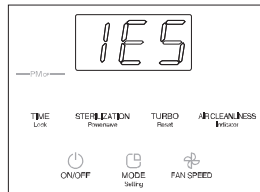

[When setting Spain language]

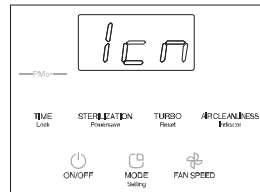

[When setting Chinese language]

How to Adjust Voice Volume

The following instructions explain how to cancel the voice option and adjust the volume.

- ❶ Begin in Standby Mode.
 - ❷ Press the MODE button for three seconds or longer to enter the language settings and then press the MODE button once again.
 - ❸ “3” is displayed on the control panel as shown in the picture below.
 - ❹ Adjust the volume by pressing the FAN SPEED button.
- (OFF setting: Silent / Level 0: BEEP output without voice / Level 1: Small voice / Level 5: Large voice)
- ❺ Press the ON/OFF button to save the setting.
- * The setting is automatically canceled if it's left idle for 20 seconds or longer.

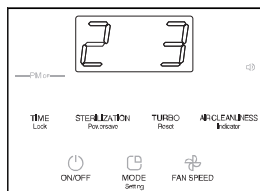

[When setting voice volume level 3]

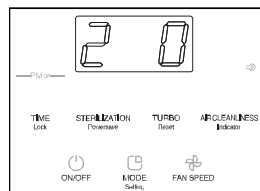

[Setting the BEEP without voice]

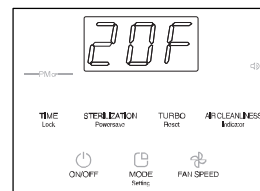

[Setting Silent]

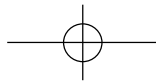

Other Settings

How to Set Filter Replacement Alarm

The following instructions show how to set and cancel the alarm for filter replacement.

- ① Begin in Standby Mode.
- ② Press the MODE button for three seconds or longer to enter the language settings and then press the MODE button again.
- ③ “On” and “Replace the Filters” are displayed on the control panel as shown in the picture below.
- ④ Press the FAN SPEED button to activate or deactivate this option.
 - * It will not emit sound for filter replacement when it is deactivated.
- ⑤ Press the ON/OFF button to save the setting.
 - * The setting is automatically canceled if it's left idle for 20 seconds or longer.

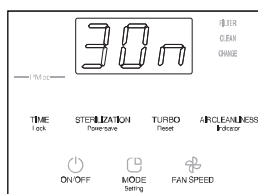

[When filter change ON is set]

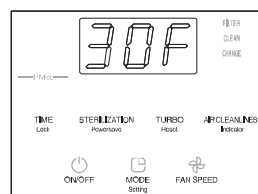

[When filter change OFF is set]

How to Set Sensor Sensitivity

Sensor sensitivity can be set to Low, Medium or High. The default level is set to Medium.

- ① Begin in Standby Mode.
- ② Press the MODE button for three seconds or longer to enter the language settings and then press the MODE button three times.
- ③ “2” is displayed on the control panel as shown in the picture below.
- ④ Press the FAN SPEED button to set the level to 1, 2 or 3.
 - * Level 1 : sets the Sensor sensitivity to Low. * Level 2 : sets the Sensor sensitivity to Medium.
 - * Level 3 : sets the Sensor sensitivity to High. * The fine dust is detected well as you set the higher level.
- ⑤ Press the ON/OFF button to save the setting.
 - * The setting is automatically canceled if it's left idle for 20 seconds or longer.

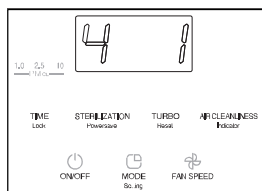

[Sensor sensitivity 1 level setting]

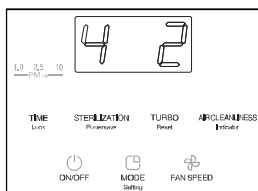

[Sensor sensitivity 2 level setting]

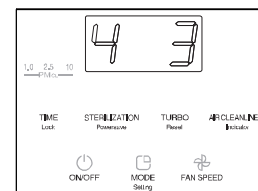

[Sensor sensitivity 3 level setting]

* The control and display panel may appear differently than the image above.

Other Settings

How to Set Screen Saver

This function allows you to save energy by adjusting brightness of the screen.

- ① Begin in Standby Mode.
- ② Press the MODE button for three seconds or longer to enter the language settings and then press the MODE button four times.
- ③ "On" is displayed on the control panel as shown in the picture below.
Press the FAN SPEED button to set this option on or off.
* The light will stay illuminated even if it is turned off.
- ④ Press the ON/OFF button to save the setting.
* The setting is automatically canceled if it's left idle for 20 seconds or longer.

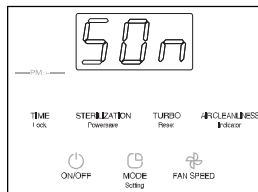

[When Energy Save ON is set]

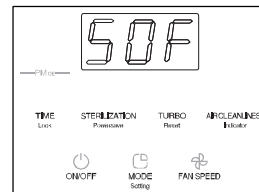

[When Energy Save OFF is set]

How to Set Energy Eye Function

The following instructions show how to set the darkness sensing range for power saving.

- ① Begin with Standby Mode.
- ② Press the MODE button for three seconds or longer to enter the language settings and then press the MODE button five times.
- ③ "2" is displayed on the control panel as shown in the picture below.
- ④ Adjust the level from OFF to 3 by pressing the FAN SPEED button.
* The higher the setting, the better the entry into the power saving mode.
(OFF: Set this level when you do not wish to use this function)
- ⑤ Press the ON/OFF button to save the setting.
* The setting is automatically canceled if it's left idle for 20 seconds or longer.

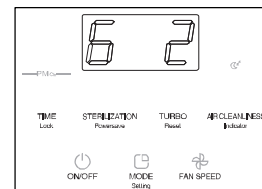

[When Energy Eye level 2 is set]

* The control and display panel may appear differently than the image above.

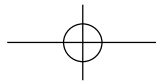

Other Settings

How to set the time for TURBO Mode

This is the setting method for the turbo operation time. It can be set to run continuously for 1 hour, 2 hours, 3 hours, 4 hours, 5 hours and non-stop.

- ① Begin at Standby Mode.
- ② Press the MODE button for three seconds or longer to enter the language settings and then press the MODE button six times.
- ③ "Co" is displayed on the control panel as shown in the picture below.
- ④ Press the FAN SPEED button to set the time to 1 hour, 2 hours, 3 hours, 4 hours, 5 hours and non-stop ("CO").
(When set to 1 hour, it returns to the previous mode after 1 hour of turbo operation.)
- ⑤ Press the ON/OFF button to save the setting.
* The setting is automatically canceled if it's left idle for 20 seconds or longer.

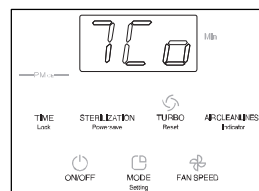

[When set to Non-stop of turbo operation]

How to Maximize wind strength in Auto mode

Setting the maximum wind strength in auto, room care, and repeat mode. It can be set OFF (up to level3) and ON (up to level 4).

- ① Begin on Standby Mode.
- ② Press the MODE button for three seconds or longer to enter the language settings and then press the MODE button seven times.
- ③ "OF" is displayed on the control panel as shown in the picture below.
- ④ Press the Fan Speed button to set the auto mode maximum wind strength (OF / On).
(When set to On, it operates up to level 4 in automatic, room care, and repeated operation mode.)
- ⑤ Press the ON/OFF button to save the setting.
(The setting is automatically canceled if it's left idle for 20 seconds or longer.)

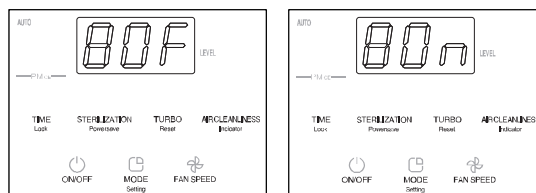

[When Auto mode Max. wind setting is OFF] [When Auto mode Max. wind setting is ON]

* The control and display panel may appear differently than the image above.

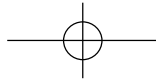

Cleaning and Maintenance Guide



How to Clean the Fine Dust Sensor (Clean once every one to two months)

① Open the filter cover.

- ▶ Open the front of the filter cover and loosen the screws on the rear of the filter cover.

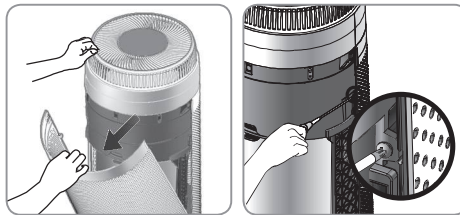

② Open the fine dust sensor cover.

- ▶ Before using, clean them with a soft brush or vacuum cleaner.

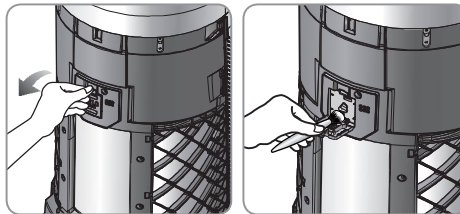

③ Carefully wipe the sensor lens with a cotton swab.

- ▶ Before using, clean them with a soft brush or vacuum cleaner.
- * If not cleaned regularly, unit may not perform at its optimal level.
- * Cleaning cycle varies depending on the environment, it requires more frequent cleaning if used in a dusty area.

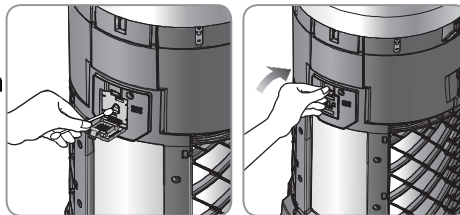

- * Except water, do not use any volatile substances including alcohol and acetone to clean the sensor.
- * If the sensor lens are covered with dust, the pollution indicator may show "Polluted" and not change. In this case, thoroughly clean the sensor again.

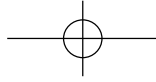

Cleaning and Maintenance Guide

How to Clean the Main Body (Clean once every two to four weeks.)

- 1 Use a slightly damp cloth and thoroughly wipe the unit.
- 2 Use a cotton swab when cleaning the dust off the exterior grooves.

※ Do not use an alkaline detergent when cleaning the control & display panel.
※ Do not use a sulfuric acid, hydrochloric acid or organic solvent including thinner and kerosene for cleaning the surface of the product. Do not attach any sticker on the surface. It may cause damage to the surface.

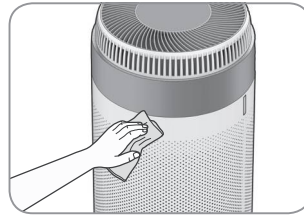

How to Clean the Air Outlet (Clean once every two to four weeks.)

- 1 Turn the grill on top of the product as shown.

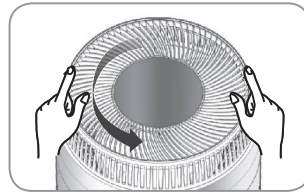

- 2 Hold your finger on the grill and pull it out as shown.

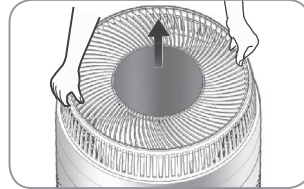

- 3 Clean the grill with a soft brush or a cleaner.

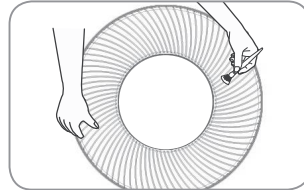

- 4 Use a soft brush or vacuum cleaner to clean the dust off the air vent.

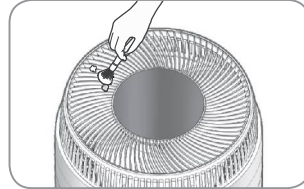

※ The cleaning cycle varies depending on the environment.

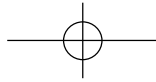

Cleaning and Maintenance Guide

How to Clean the Pre-Filter (Clean once every two to four weeks.)

- The Pre-Filter can be reused after the dust is removed or washed in water.
- The Harmful Gas Easy Filter, Deodorization Filter, and Ultra PM 2.5 Filter cannot be reused even after cleaning.
- If the cleaning LED lights up, clean the pre-filter.
- The filter cleaning cycle may vary depending on the surrounding environment.

① Open the filter cover.

- ▶ Open the Filter Cover by pulling the upper part of each side of the Filter Cover.
- ※ Gently remove the cover by starting at the top of the cover.

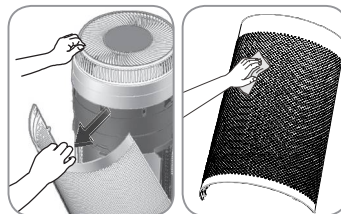

② Remove the dust attached to the filter cover surface lightly with soft, dry cloth or soft brush.

③ Remove the Ultra-Deo PM 2.5 Filter from the product and remove the dust on the surface using a vacuum cleaner.

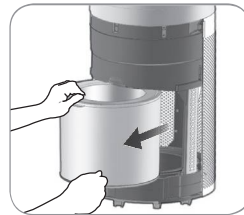

④ Clean the pre-filter attached to the Ultra-Deo PM 2.5 Filter by removing the dust or remove the pre-filter and wash with lukewarm water.

- ▶ Wash the removed filter in water and dry it out away from sunlight.
- ※ If wet, it may cause a malfunction or odor.

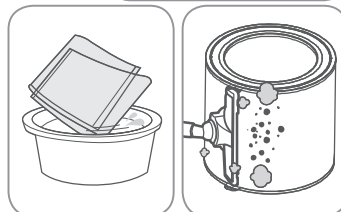

Caution

- ※ If you wash it with hot water or dry it in direct sunlight, the Filter may become deformed.

⑤ Attach the pre-filter to the Ultra-Deo Pm 2.5 Filter. After attaching to the product, reinstall the filter cover.

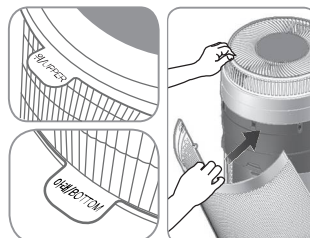

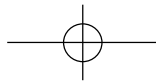

How To Replace the Filters

- If the Filter replacement LED lights up, please replace the filter.
- Always unplug the power cord before replacing a filter.
- If the filter is used over the cleaning or replacement cycle, it may degrade the performance or emit odor.
- Please use genuine CUCKOO filters only.
- A torn or wet Air Purifying Filter must be replaced with a new one. Contact our Customer Service Center to purchase filters.

Filter Cleaning and Replacement Cycle

Filter		Cleaning / Replacement	Note
Pre-Filter		Once / 2~4 weeks	Cleaning & Washing
Functional Filter	Allergen Filter	Once / 4 months	Replacement
Ultra-Deo PM 2.5 Filter		Once / 12 months	Replacement

※ Filter replacement cycle may differ depending on the environment and time of use.

※ The life test of Ultra PM 2.5 Filter and Deodorizing Filter is done by JEMA1467 (Air cleaners of household and similar use) evaluated the life span by burning tobacco.

How to Replace the Air Purifying Filter

Check the upper part of the Filter before replacing it.

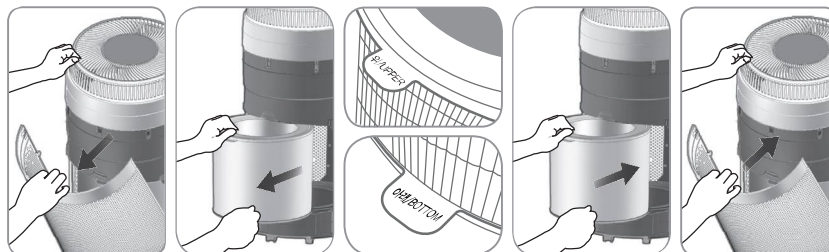

- ⊘ If the Top (upper) of the filter is inserted facing downwards, air cleaning may not function properly and may lead to product malfunction.

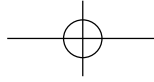

Please check before asking for Support.

▼ If you do not comply with this user manual, the device may not work properly. Please read the following measures accordingly if there is a problem with the product. If there is still a problem, please contact our Customer Service Center.

Problem	Checklist	Recommendation
The product won't work even if I press the Power button.	<ul style="list-style-type: none">• Is the power cord plugged into the power outlet?• Is there a black out?• Is the product properly assembled?• Have you pressed the ON/OFF button?	<ul style="list-style-type: none">• Put the Power Plug in a Power Outlet of 120V, 60Hz.• Use the product after electricity is supplied.• Assemble the product properly.• Press the ON/OFF button.
The volume won't change.	<ul style="list-style-type: none">• Is the product in the MANUAL mode?• Is the product in the SLEEP or BABY mode?	<ul style="list-style-type: none">• Choose your preferred mode.• In Sleep or Baby mode, the air volume is fixated to be the minimum air volume.
The air does not seem to be purified.	<ul style="list-style-type: none">• Is the indoor air overly polluted?• Is the room too large?• Is there any obstacle around the product?• Is the product installed where wind cannot move freely?• Has the time for filter cleaning and replacement passed?	<ul style="list-style-type: none">• Ventilate the room and then use the product.• Use the product in an area not exceeding its coverage limit. (Avoid placing the device where it is well ventilated like a near door or window.)• Remove any objects surrounding the unit.• Install the product elsewhere.• Check the Filter cleaning and replacement cycle and clean or replace the Filters.
There is an odor coming from the air vent.	<ul style="list-style-type: none">• Did the odor get released in the initial use of the product not long after purchase?• Do you use the product in a place with a lot of smoke or smell?• Has the time for filter cleaning and replacement passed?	<ul style="list-style-type: none">• The odor is an activated carbon. The odor will disappear in one to two weeks after the product starts operation. It is a smell of an activated carbon (charcoal) which is harmless to the human body.• The performance of the unit may decrease if there is excessive smoke. Please air out the room before using the product.• Check the Filter cleaning and replacement cycle and clean or replace the filters.
A noise comes out of the device.	<ul style="list-style-type: none">• Is it a clinking sound?	<ul style="list-style-type: none">• In STERILIZATION mode, a clinking sound may be made due to the generation of ion.
The color of the air purification status display is always the same.	<ul style="list-style-type: none">• Is there dust on the Lens of the Dust Sensor?• Does the dust pollution status continue on low or high?	<ul style="list-style-type: none">• Clean the lens of the dust sensor.• Set the sensor sensitivity to Level 1 (Low) or Level 3 (High).
When other functional defects occur	<ul style="list-style-type: none">• Diagnose the problem, unplug the power cord and contact our Customer Service Center.	

Product Specifications

Category	Air Purifier
Model name	CAC-D2010FW
Rated Voltage and Current	120V, 60Hz
Rated Power Consumption	65W(1.3A)
Insulation Rating	Type 2 device
Dust Collecting Method	Mechanical dust collecting method
Safety Device	Power will be deactivated when the door is being opened or closed.
Place for Use	For indoors
Effective Reach Area	711sqft(66m ²)
Product Size	15.6" x 15.6" x 29.7"
Product Weight	24.25lb

※The information (exterior, design, and specifications) provided in this User Manual is subject to change.
※This appliance is intended for home use (Class B) and is suitable for home use. It can be used in all areas.

Inquiry about Malfunction

Product parts may wear out due to heat, moisture, dust over time, which in turn may cause malfunction of the product.

In the case that

- ❶ "Check before reporting a malfunction." in page 31 occurs;
- ❷ You can feel electricity when you touch the product with your hands; ❸ The power is supplied, but the Motor does not work
- ❹ Other malfunctions occur

Please stop using the product.

Please unplug the product and visit www.cuckooamerica.com for customer service.

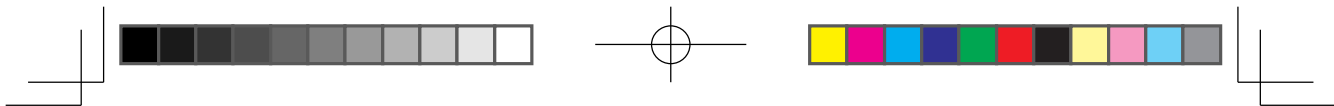

MEMO

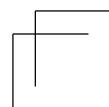
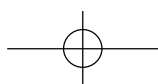
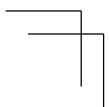
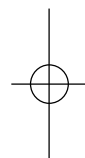
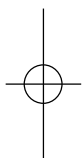

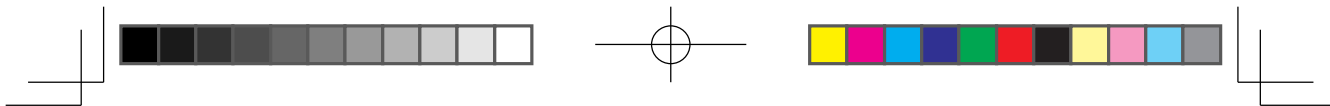

MEMO

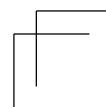
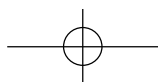
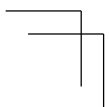
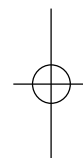
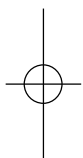

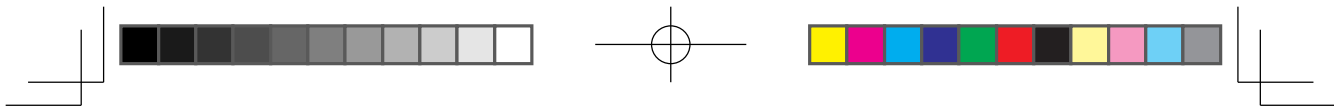

MEMO

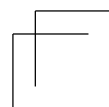
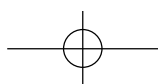
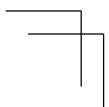
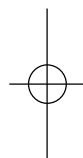
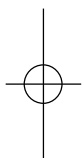

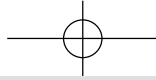

CUCKOO

<http://www.cuckooamerica.com>

We provide satisfying consultation and services concerning your complaints, suggestions, and recommendations upon receiving your troubled product model name, status, and contact information.

- ♣ After reading this manual, keep it in a place easily accessible to the user for future reference.
- ♣ This manual includes the warranty.
- ♣ Caution : Please read this manual carefully to ensure safety and a longer product lifespan.

10383-0005J0 Rev.1